

LISTINO PREZZI | 20
PRICE LIST | 26

SOL
RUBINETTERIE

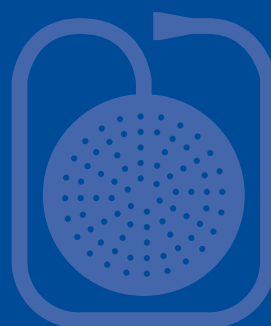

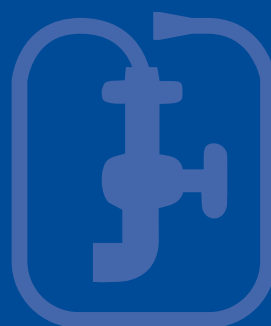
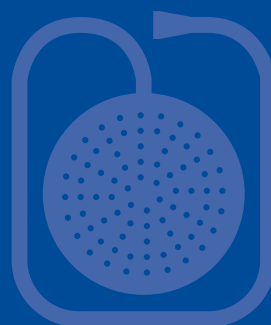
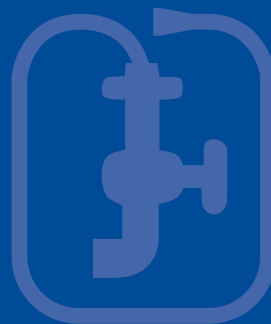

SOL: l'evoluzione di una storia italiana

Dal 1960, SOL è sinonimo di concretezza. Oggi, quel DNA storico rinasce in una linea 2026 completamente rinnovata, pensata per chi cerca valore e sostanza. Abbiamo preso sessant'anni di esperienza nella rubinetteria sanitaria e li abbiamo proiettati nel presente: il risultato è la miglior espressione di soluzioni per bagno e cucina che massimizzano il rapporto qualità-prezzo. Non è solo un listino, con SOL trasferiamo valore al mercato.

Oltre il prodotto: soluzioni per il professionista

L'accurata selezione dei materiali e i test al 100% su ogni singolo pezzo sono il nostro biglietto da visita. Per te che progetti, distribuisce o installi, SOL significa affidabilità senza compromessi. Con un packaging divertente, funzionale e un design moderno, offriamo una gamma completa che copre ogni esigenza tecnica. Entrare nel mondo SOL oggi significa scegliere prodotti nati per durare, pensati per rendere ogni intervento semplice, curato e accessibile. La qualità, finalmente, è per tutti.

SOL: the evolution of an Italian story

Since 1960, SOL has been synonymous with tangibility. Today, that historical DNA is reborn in a completely renewed 2026 line, designed for those seeking value and substance. We have taken sixty years of experience in sanitary tapware and projected it into the present: the result is the ultimate expression of bathroom and kitchen solutions that maximize the quality-price ratio. This is not just a price list; with SOL, we transfer value to the market.

Beyond the product: solutions for the professional

Accurate material selection and 100% testing on every single piece are our calling card. For those who design, distribute, or install, SOL means uncompromising reliability. With fun, functional packaging and modern design, we offer a complete range covering every technical need. Entering the world of SOL today means choosing products built to last, designed to make every intervention simple, polished, and accessible. Finally, quality is for everyone.



SOL: il valore che muove il tuo business

In un mercato affollato da nomi storici e strutture complesse, SOL rappresenta la scelta di chi guarda ai risultati. Non siamo solo un'alternativa: siamo il partner strategico che trasforma il catalogo in rotazione di magazzino e il preventivo in vendita conclusa.

Perché scegliere SOL oggi?

- **Agilità contro Burocrazia:** noi rispondiamo in tempo reale. Offriamo la flessibilità di un'azienda snella unita alla solidità di una storia che dura dal 1960. Meno attese, più risposte.
- **Qualità Senza Sovrapprezzo:** Abbiamo eliminato i costi inutili per trasferire tutto il valore direttamente sul prodotto. Con SOL, offri ai tuoi clienti uno standard tecnico eccellente — testato al 100% — a un posizionamento di prezzo che massimizza il tuo margine e la soddisfazione dell'utente finale.
- **Praticità per chi lavora:** Ogni nostra scelta, dal design delle serie BOSS, AURORA e ALBA fino al packaging funzionale, è pensata per semplificare la vita a chi installa e a chi vende. Prodotti pronti all'uso, facili da gestire e progettati per durare.
- **Una Visione Comune:** Non puntiamo a riempire i tuoi scaffali, ma a svuotarli velocemente. Collaborare con SOL significa scegliere una crescita costante e sostenibile, basata su prodotti che rispondono alle reali esigenze del mercato attuale: estetica moderna, affidabilità totale e il miglior rapporto qualità-prezzo del settore.

SOL. Qualità certa, valore condiviso

SOL: the value that moves your business

In a market crowded with heritage names and complex structures, SOL is the choice for those who focus on results. We are not just an alternative: we are the strategic partner that transforms a catalog into stock rotation and a quote into a closed sale.

Why choose SOL today?

- **Agility vs. Bureaucracy:** We respond in real-time. We offer the flexibility of a lean company combined with the solidity of a history dating back to 1960. Less waiting, more answers.
- **Quality Without the Premium:** We have eliminated unnecessary costs to transfer all the value directly to the product. With SOL, you offer your customers an excellent technical standard—100% tested—at a price positioning that maximizes your margin and end-user satisfaction.
- **Practicality for Professionals:** Every choice we make, from the design of the BOSS, AURORA, and ALBA series to the functional packaging, is designed to simplify life for those who install and those who sell. Products ready to use, easy to manage, and built to last.
- **A Shared Vision:** We don't aim to fill your shelves, but to empty them quickly. Partnering with SOL means choosing constant and sustainable growth, based on products that meet the real needs of today's market: modern aesthetics, total reliability, and the best value-for-money in the industry.

SOL. Proven quality, shared value.



Sistema espositivo SOL: valore in mostra, ovunque

La doppia basetta SOL non è un semplice supporto, ma un vero strumento di vendita dinamico, progettato per portare la qualità dei nostri prodotti esattamente dove serve. Grazie a un design intelligente, questo sistema offre una **versatilità senza pari**: stabile ed elegante per l'esposizione su bancone nel punto vendita, ma allo stesso tempo agile per essere trasportato direttamente in cantiere.

È la soluzione ideale per il professionista che vuole toccare con mano la sostanza dei materiali e mostrare al cliente finale il valore reale della scelta SOL. Pratica, essenziale e immediatamente pronta all'uso, la doppia basetta trasforma ogni spazio in un'area espositiva professionale, ottimizzando l'ingombro e massimizzando l'impatto visivo. Perché un prodotto SOL non va solo descritto: va mostrato nella sua concretezza.

SOL display system: value on display, everywhere

The SOL double-base display is not just a support, but a truly dynamic sales tool, designed to bring the quality of our products exactly where it's needed. Thanks to its smart design, this system offers **unmatched versatility**: stable and elegant for showroom counter displays, yet agile enough to be taken directly to the job site.

It is the ideal solution for the professional who wants to experience the substance of the materials firsthand and demonstrate the true value of the SOL choice to the end customer. Practical, essential, and ready for immediate use, the double-base system transforms any space into a professional display area, optimizing the footprint while maximizing visual impact. Because a SOL product shouldn't just be described: it must be shown in all its tangibility.

BOSS

La forza dell'acciaio, il carattere del design

La serie BOSS ridefinisce il concetto di essenzialità. Interamente realizzata in **acciaio AISI 304**, è progettata per chi non accetta compromessi tra resistenza e stile. Disponibile nelle finiture **acciaio spazzolato** e nel prezioso **oro PVD**, BOSS trasforma la robustezza industriale in un'estetica ricercata e moderna.

Non è solo una questione di look: con una gamma completa che offre soluzioni per ogni configurazione, BOSS è lo strumento perfetto per il professionista che cerca praticità estrema e un impatto visivo superiore. **Un'eccellenza che restituisce un valore superiore al prezzo**, garantendo un'impronta di carattere a qualsiasi progetto.

The strength of steel, the character of design

The BOSS series redefines the concept of essentiality. Entirely crafted from AISI 304 stainless steel, it is designed for those who refuse to compromise between durability and style. Available in brushed steel and precious PVD gold finishes, BOSS transforms industrial robustness into a sophisticated, modern aesthetic.

It's not just about looks: with a comprehensive range offering solutions for every configuration, BOSS is the perfect tool for the professional seeking extreme practicality and superior visual impact. An excellence that delivers superior value over price, ensuring a touch of character for any project.





BOSS



ALBA

La nuova forma della praticità

La serie Alba è dedicata a chi cerca un equilibrio superiore tra estetica e comfort. Caratterizzata da **forme morbide ed eleganti**, questa linea in ottone infonde una nuova luce all'ambiente bagno, sottraendo peso visivo per aggiungere stile. Ogni elemento è il risultato di un design studiato per esaltare la **praticità di utilizzo**, rendendo ogni gesto quotidiano semplice, fluido e immediato.

Non lasciarti ingannare dalla sua linea sottile: Alba nasconde una solidità strutturale pensata per chi esige prestazioni costanti nel tempo. È la soluzione ideale per il professionista che vuole proporre un'alternativa di carattere e soprattutto di valore, capace di unire un'estetica moderna e "leggera" a una facilità d'installazione e manutenzione senza pari.

Con Alba, il design funzionale diventa finalmente un piacere quotidiano.

The new shape of practicality

The Alba series is dedicated to those seeking a superior balance between aesthetics and comfort. Characterized by soft, elegant shapes, this brass line infuses new light into the bathroom, reducing visual weight to add style. Every element is the result of a design studied to enhance ease of use, making every daily gesture simple, fluid, and immediate.

Do not be fooled by its slender silhouette: Alba hides a structural solidity designed for those who demand consistent performance over time. It is the ideal solution for the professional who wants to offer an alternative of character and, above all, of value, capable of combining modern "light" aesthetics with unparalleled ease of installation and maintenance. With Alba, functional design finally becomes a daily pleasure.

AURORA

L'armonia del rigore, il piacere dell'ergonomia

La serie Aurora nasce per essere il cuore pulsante di ogni ambiente bagno. Progettata con un rigore tecnico che non lascia nulla al caso, la collezione eleva lo standard della rubinetteria quotidiana. Ogni dettaglio è stato studiato per offrire un'esperienza d'uso fluida e naturale, dove l'attenzione ai principi costruttivi si traduce in una durata eccezionale.

È la scelta di chi cerca una soluzione concreta e funzionale, senza rinunciare a un design pulito che si adatta a ogni contesto. Per il professionista, Aurora rappresenta la certezza di un prodotto impeccabile: ergonomia superiore e precisione millimetrica si fondono in una gamma versatile, capace di dare valore alle reali esigenze di progetto.







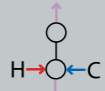

The harmony of rigor, the pleasure of ergonomics

The Aurora series was born to be the beating heart of every bathroom. Designed with technical rigor that leaves nothing to chance, this collection elevates the standard of everyday tapware. Every detail has been studied to offer a fluid and natural user experience, where attention to construction principles translates into exceptional durability.

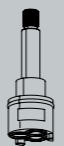
It is the choice for those seeking a concrete and functional solution without sacrificing a clean design that adapts to any context. For the professional, Aurora represents the certainty of a flawless product: superior ergonomics and millimetric precision merge into a versatile range, capable of giving value to real project needs.



LEGENDA

 2 Ingressi - 1 Uscita 2 Inlets - 1 Outlet	 2 Ingressi - 2 Uscite - Deviatore 2 Inlets - 2 Outlets - Diverter	 Cartuccia miscelatrice Mixing cartridge	 Cartuccia deviatore Diverter cartridge
 Filetti gas 3/8" 3/8" connection	 Filetti gas 1/2" 1/2" connection	 Aeratore Aerator	 Chiavetta aeratore Aerator key
 Pezzi per cartone Pcs per box			

COME ORDINARE | HOW TO ORDER

56S400S4 è in finitura acciaio spazzolato **S4** Stands for brushed stainless steel
56S400VG è in finitura oro spazzolato PVD **VG** PVD Stands for brushed PVD gold
44S411C è in finitura cromo **C** Stands for chrome

FINITURE | FINISHING

Cromo Chrome	Acciaio spazzolato Brushed stainless steel	Oro spazzolato PVD Brushed PVD gold
		

INDICE | INDEX



15
BOSS

La forza dell'acciaio, il carattere del design.



23
ALBA

Design studiato per la praticità di utilizzo, unito alla leggerezza delle forme morbide ed eleganti.



35
AURORA

Ergonomica, progettata con rigore ed attenzione ai dettagli.



47
RICAMBI | SPARES



50
Cura e manutenzione
Care and maintenance



51-52
Condizioni di vendita e garanzia
Conditions of sale and warranty



BOSS

La forza dell'acciaio, il carattere del design.

BOSS

Design: SOL Design Team



BOSS



Miscelatore lavabo senza scarico
Washbasin mixer without waste

Cod.
56S400S4
56S400VG

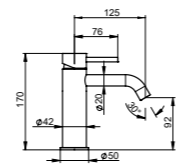
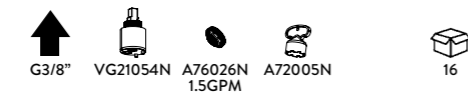

Miscelatore bidet senza scarico
Bidet mixer without waste

Cod.
56S500S4
56S500VG

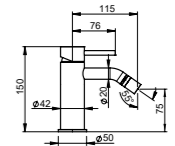
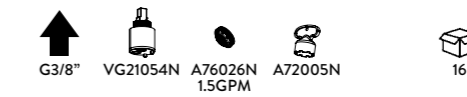

Piletta universale click-clack
Click-clack waste

Cod.
PIS101-037S4
PIS101-037VG

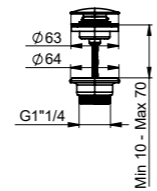

Miscelatore monocomando vasca esterno con flessibile e doccia ABS
Bath mixer with flexible hose and ABS hand-shower

Cod.
56S100S4
56S100VG

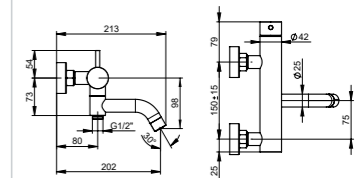

Miscelatore lavabo alto senza scarico
Tall washbasin mixer without waste

Cod.
56S450S4
56S450VG

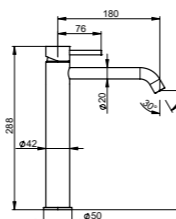
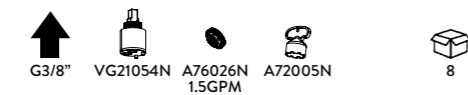

Miscelatore lavabo incasso bocca 22 cm senza scarico
22 cm spout concealed wash-basin mixer without waste

Cod.
56S350S4
56S350VG

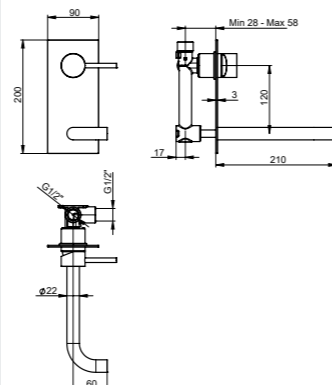

BOSS



Miscelatore monocomando incasso 1 via
1 way built-in shower mixer

Cod.
56S250S4
56S250VG

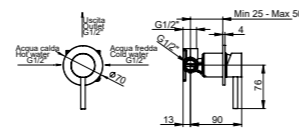

Miscelatore monocomando incasso 2 vie
2 ways built-in shower mixer

Cod.
56S200S4
56S200VG

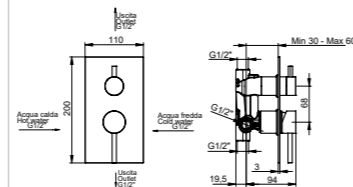
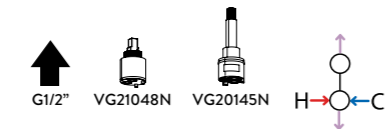

Kit prolunga miscelatore incasso 1 via + 2 cm
2 cm extension kit for 1 way built-in mixer

Cod.
PRO-250SS4
PRO-250SVG



Kit prolunga miscelatore incasso 2 vie + 2 cm
2 cm extension kit for 2 ways built-in mixer

Cod.
PRO-200SS4
PRO-200SVG

BOSS



Kit Doccia BOSS25 con soffione in acciaio 304 25 cm
presa acqua con supporto braccio doccia 30 cm flessibile
PVC doccia minimale

Shower set 25 cm stainless steel showerhead water plug
with shower rack, 30 cm shower arm hand shower and
PVC flexible hose

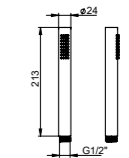
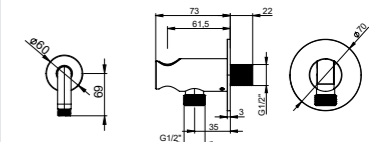
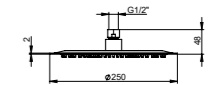
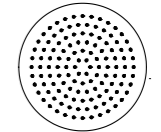
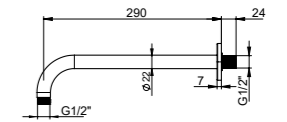

Cod.
KIT-S-T250S4
KIT-S-T250VG



Colonna doccia telescopica tonda acciaio 304 con
miscelatore 2 uscite soffione 25 cm flessibile PVC

Adjustable shower column with mixer 304 stainless steel
25 cm shower head

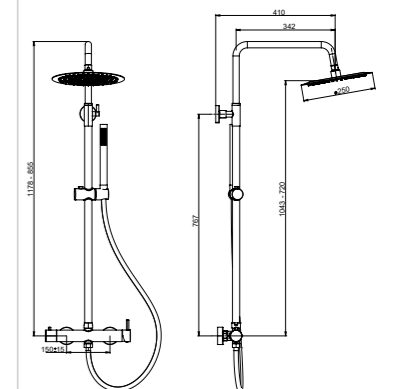

Cod.
23S5610S4
23S5610VG



BOSS



Braccio doccia 30 cm
Round 30 cm shower arm

Cod.
BR2S14S4
BR2S14VG



G1/2"



16

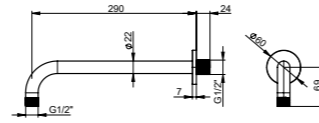

BOSS



Flessibile in PVC cono 1/2" F - dado 1/2" F 150 cm
Flexible hose 150 cm. flexible hose 1/2" f - 1/2" conic

Cod.
G50S064S4
G50S064VG



G1/2"



50



Presca acqua tonda in ottone con supporto doccia
Round water plug with shower rack

Cod.
G24S093S4
G24S093VG



G1/2"



16

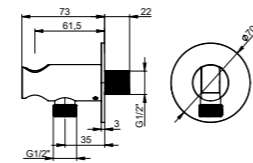

Soffione tondo in acciaio 304 diam. 25 cm
304 stainless steel, 25 cm diameter round shower head

Cod.
G26S239S4
G26S239VG



G1/2"



20

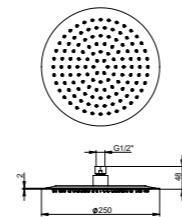

Doccetta tonda monogetto anticalcare
Round single jet anti lime hand shower

Cod.
G26S238S4
G26S238VG



G1/2"



20

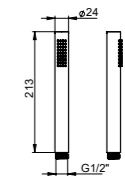

Sifone sotto-lavabo
Round bottle-trap

Cod.
S11S13S4
S11S13VG



G 1 1/4"



20

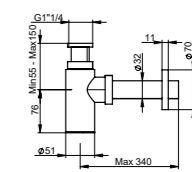

ALBA

Design: SOL Design Team



ALBA

Design studiato per la praticità di utilizzo, unito alla leggerezza delle forme morbide ed eleganti.

ALBA



Miscelatore monocomando lavabo scarico automatico da 1"1/4
Wash-basin mixer with 1"1/4 pop-up waste

Cod.
44S411C

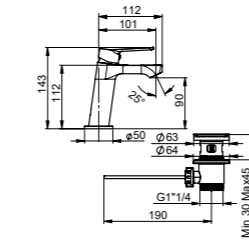

Miscelatore lavabo incasso bocca 22 cm senza scarico
22 cm spout concealed wash-basin mixer without waste

Cod.
45S350C

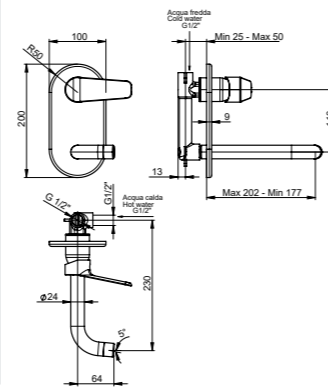

Miscelatore monocomando bidet con scarico automatico da 1"1/4
Bidet mixer with 1"1/4 pop-up waste

Cod.
44S511C

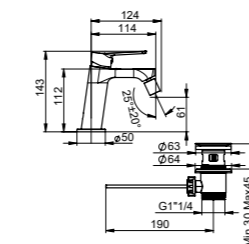
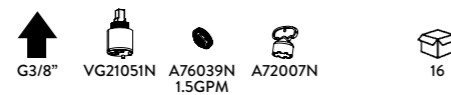

Miscelatore monocomando vasca esterno con flessibile e doccia ABS
Bath mixer with flexible hose and ABS hand-shower

Cod.
45S100C

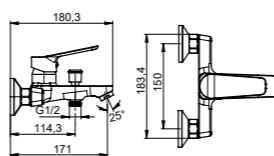

ALBA



Miscelatore monocomando incasso 1 via
1 way built-in shower mixer

Cod.
45S250C

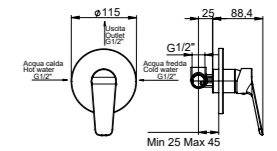
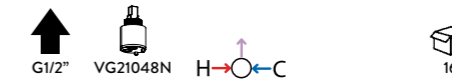

Miscelatore monocomando incasso 2 vie
2 ways built-in shower mixer

Cod.
45S200C

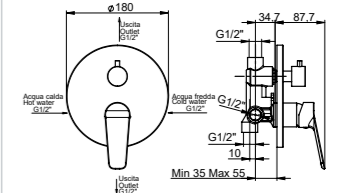
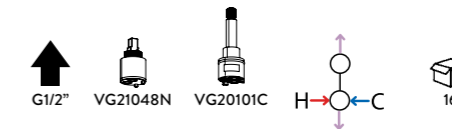

Kit prolunga miscelatore incasso 1 via + 3 cm
3 cm extension kit for 1 way built-in mixer

Cod.
PRO-250S



Kit prolunga miscelatore incasso 2 vie + 3 cm
3 cm extension kit for 2 ways built-in mixer

Cod.
PRO-200S

□ ALBA



Kit Doccia ALBA20 cromo, con soffione in acciaio 304 diam. 20 cm, presa acqua ottone con supporto, braccio doccia 30cm, flessibile in acciaio 304 cromato, doccia tonda ABS

Chrome shower set, 20cm diameter stainless steel showerhead, brass water plug with shower rack, 30cm shower arm, chrome stainless steel flexible hose, round ABS hand-shower

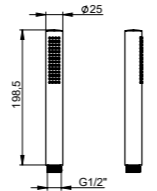
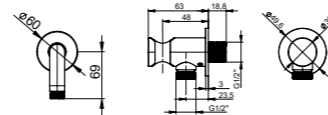
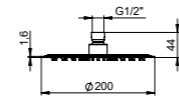
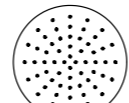
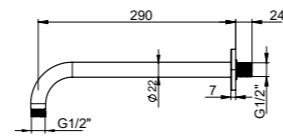

Cod.
Flex 304 ■ **KIT-S-T200C**
Flex PVC ■ **KIT-S-T200-2C**



□ ALBA



Kit Doccia ALBA30 cromo, con soffione in acciaio 304 diam. 30 cm, presa acqua ottone con supporto, braccio doccia 40cm, flessibile in acciaio 304 cromato, doccia tonda ABS

Chrome shower set, 30cm diameter stainless steel showerhead, brass water plug with shower rack, 40cm shower arm, chrome stainless steel flexible hose, round ABS hand-shower

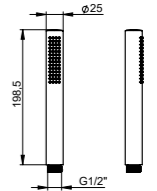
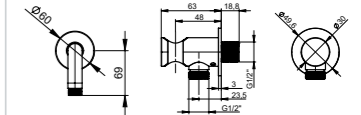
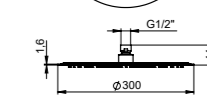
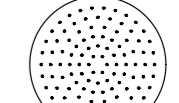
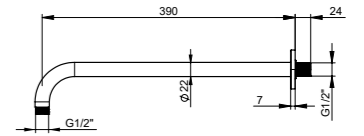

Cod.
Flex 304 ■ **KIT-S-T300C**
Flex PVC ■ **KIT-S-T300-2C**



Kit Doccia ALBA25 cromo, con soffione in acciaio 304 diam. 25 cm, presa acqua ottone con supporto, braccio doccia 30cm, flessibile in acciaio 304 cromato, doccia tonda ABS

Chrome shower set, 25cm diameter stainless steel showerhead, brass water plug with shower rack, 30cm shower arm, chrome stainless steel flexible hose, round ABS hand-shower

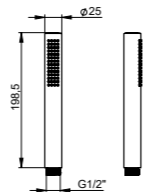
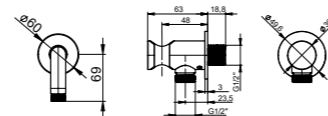
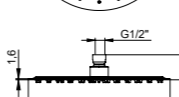
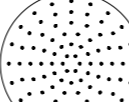
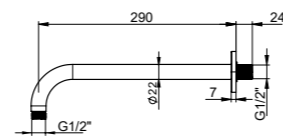

Cod.
Flex 304 ■ **KIT-S-T250C**
Flex PVC ■ **KIT-S-T250-2C**



Colonna doccia telescopica con miscelatore, soffione tondo acciaio 304 diam. 25 cm, doccia tonda ABS

Adjustable shower column with mixer, 25 cm diameter 304 stainless steel showerhead, round ABS hand-shower

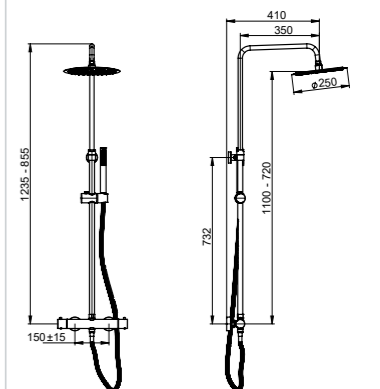

Cod.
Flex 304 ■ **22S4410C**
Flex PVC ■ **22S4410-2C**



ALBA



Colonna doccia telescopica, soffione tondo acciaio 304 diam. 25 cm, doccetta tonda ABS, con presa acqua inferiore da 1/2 m e flessibile di collegamento
Adjustable shower column with water plug, 25 cm diameter 304 stainless steel showerhead, ABS hand-shower

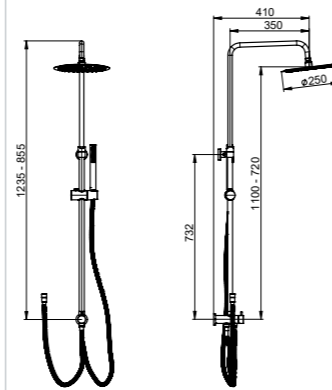

Cod.
22S4400C

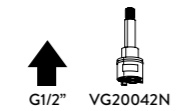

Presca acqua
Round water plug



Cod.
G24S005C

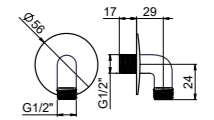

Braccio doccia tondo a parete da 30 cm
Round 30 cm shower arm



Cod.
BRS103C

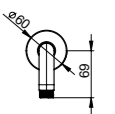
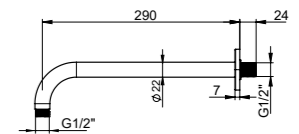

Braccio doccia tondo a parete da 40 cm
Round 40 cm shower arm



Cod.
BRS101C

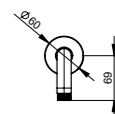
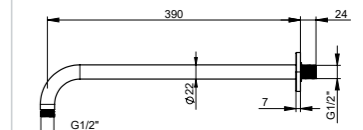

Miscelatore esterno doccia
Wall mount shower mixer



Cod.
45S300C

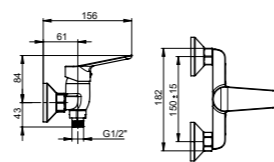

Presca acqua tonda in ottone con supporto doccia
Round water plug with shower rack



Cod.
G24S029C

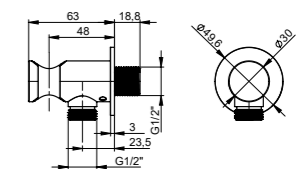

Saliscendi regolabile con doccia 3 getti e flessibile pvc 150 cm
Adjustable sliding rail with 3 jets shower and 150 cm PVC flexible hose



Cod.
S2S21C

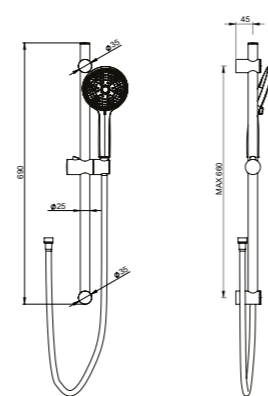

ALBA



Soffione tondo in acciaio 304 diam. 20 cm
304 stainless steel, 20 cm diameter round showerhead

Cod.
G26S060C



G1/2"



28

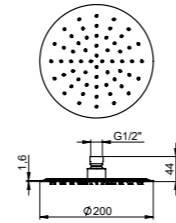

Soffione tondo in acciaio 304 diam. 25 cm
304 stainless steel, 25 cm diameter round showerhead

Cod.
G26S112C



G1/2"



9

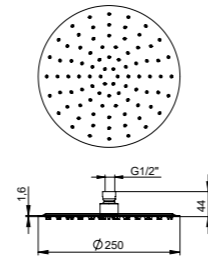

Soffione tondo in acciaio 304 diam. 30 cm
304 stainless steel, 30 cm diameter round showerhead

Cod.
G26S041C



G1/2"



7

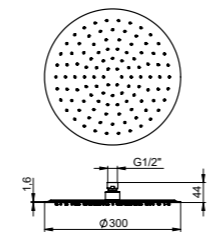

ALBA



Flessibile cm. 150 Acciaio 304 cromato a doppia
graffatura 1/2" - 1/2" conico
Double interlock chromed Aisi 304 stainless steel 150
cm. flexible hose 1/2" f - 1/2" conic

Cod.
G50S006C



G1/2"



50



Flessibile PVC cono 1/2" F - dado 1/2" F 150 cm
PVC flexible hose 150 cm. flexible hose 1/2" F - 1/2"
conic

Cod.
G50S002C



G1/2"



50



Doccetta tonda monogetto anticalcare in ABS
ABS round single jet anti lime hand shower

Cod.
G26S204C



G1/2"



20

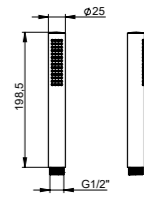

Piletta click-clack ABS
ABS click-clack waste

Cod.
P11S03



10

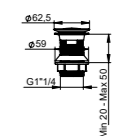

□ ALBA



Miscelatore monocomando per cucina
Kitchen mixer

Cod.
■ 45S950C

↑ G3/8" A76010N

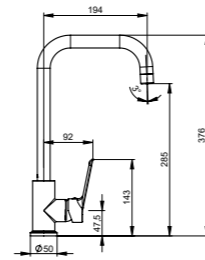

Miscelatore monocomando per cucina
Kitchen mixer

Cod.
■ 45S700C

↑ G3/8" VG21048N A76010N

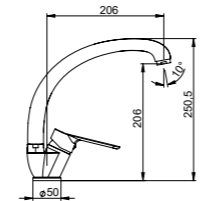

Miscelatore lavello a parete
Wall mount kitchen mixer

Cod.
■ 45S850C

↑ G1/2" VG21048N A76010N

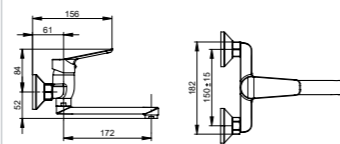

AURORA

Design: SOL Design Team



AURORA

Ergonomica, progettata con rigore ed attenzione ai dettagli.

□ **AURORA**



Miscelatore monocomando lavabo scarico automatico da 1"1/4
Wash-basin mixer with 1"1/4 pop-up waste

Cod.
■ **45S401C**

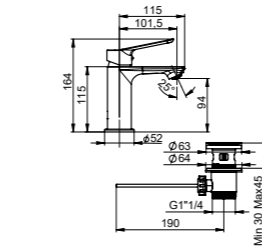

□ **AURORA**



Miscelatore monocomando incasso 1 via
1 way built-in shower mixer

Cod.
■ **45S250C**

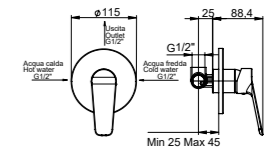
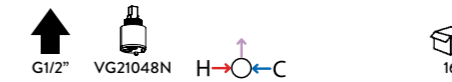

Miscelatore lavabo incasso bocca 22 cm senza scarico
22 cm spout concealed wash-basin mixer without waste

Cod.
■ **45S350C**

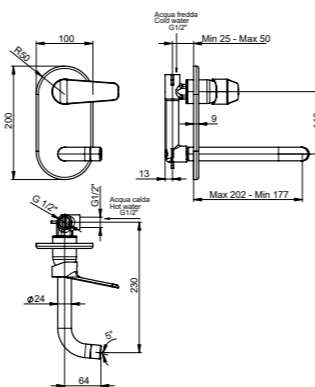

Miscelatore monocomando incasso 2 vie
2 ways built-in shower mixer

Cod.
■ **45S200C**

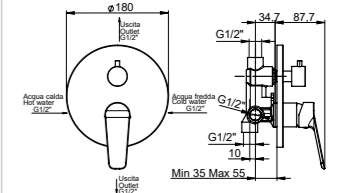
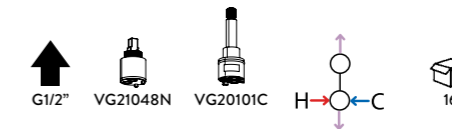

Miscelatore monocomando bidet con scarico automatico da 1"1/4
Bidet mixer with 1"1/4 pop-up waste

Cod.
■ **45S501C**

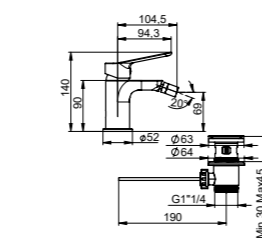
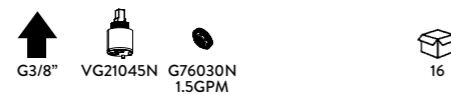

Miscelatore monocomando vasca esterno con flessibile e doccia ABS
Bath mixer with flexible hose and ABS hand-shower

Cod.
■ **45S100C**

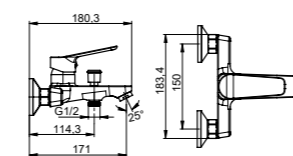

Kit prolunga miscelatore incasso 1 via + 3 cm
3 cm extension kit for 1 way built-in mixer

Cod.
PRO-250S



Kit prolunga miscelatore incasso 2 vie + 3 cm
3 cm extension kit for 2 ways built-in mixer

Cod.
PRO-200S

□ **AURORA**



Kit Doccia AURORA20 cromo, con soffione in acciaio 304, 20x20 cm, presa acqua ottone con supporto, braccio doccia 30cm, flessibile in acciaio 304 cromato, doccia quadra ABS

Chrome shower set, 20 x 20cm stainless steel showerhead, brass water plug with shower rack, 30cm shower arm, chrome stainless steel flexible hose, square ABS hand-shower.

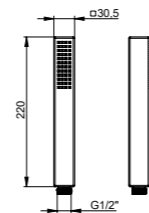
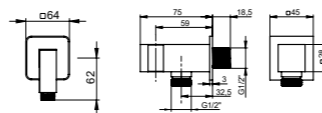
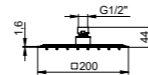
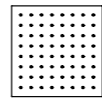
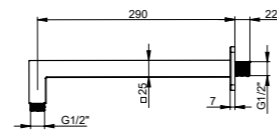

Cod.
Flex 304 ■ **KIT-S-Q200C**
Flex PVC ■ **KIT-S-Q200-2C**



G1/2"



8



Kit Doccia AURORA25 cromo, con soffione in acciaio 304, 25x25 cm, presa acqua ottone con supporto, braccio doccia 30cm, flessibile in acciaio 304 cromato, doccia quadra ABS

Chrome shower set, 25 x 25cm stainless steel showerhead, brass water plug with shower rack, 30cm shower arm, chrome stainless steel flexible hose, square ABS hand-shower

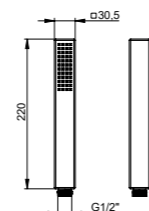
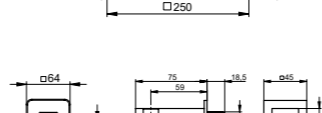
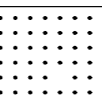
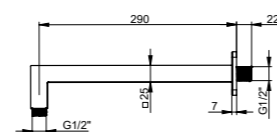

Cod.
Flex 304 ■ **KIT-S-Q250C**
Flex PVC ■ **KIT-S-Q250-2C**



G1/2"



4

□ **AURORA**



Kit Doccia AURORA30 cromo, con soffione in acciaio 304, 30x30 cm, presa acqua ottone con supporto, braccio doccia 40cm, flessibile in acciaio 304 cromato, doccia quadra ABS

Chrome shower set, 30 x 30cm stainless steel showerhead, brass water plug with shower rack, 40cm shower arm, chrome stainless steel flexible hose, square ABS hand-shower

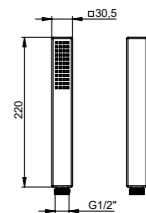
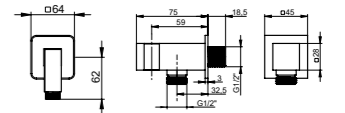
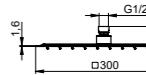
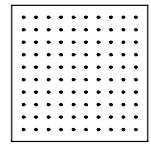
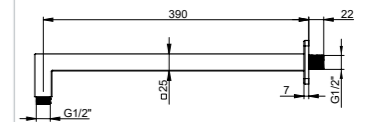

Cod.
Flex 304 ■ **KIT-S-Q300C**
Flex PVC ■ **KIT-S-Q300-2C**



G1/2"



4



Colonna doccia telescopica, soffione quadro acciaio 304, 25 x 25 cm, doccetta quadra ABS

Adjustable shower column with mixer, 25 x 25 cm 304 stainless steel showerhead, square ABS hand-shower

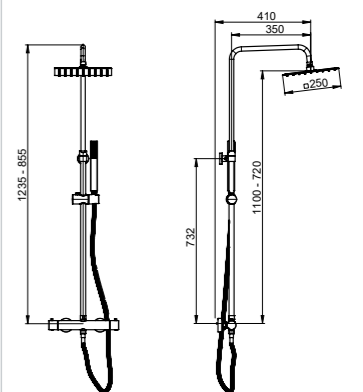

Cod.
Flex 304 ■ **22S4510C**
Flex PVC ■ **22S4510-2C**



G1/2"



VG21052N



VG20144N



3

□ **AURORA**



Soffione quadro in acciaio 304, 20 x 20 cm
304 stainless steel, 20 x 20 cm square showerhead

Cod.
G26S061C



G1/2"



28

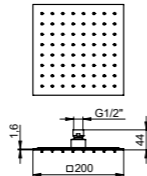

Soffione quadro in acciaio 304, 25 x 25 cm
304 stainless steel, 25 x 25 cm square showerhead

Cod.
G26S113C



G1/2"



9

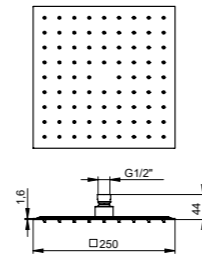

Soffione quadro in acciaio 304, 30 x 30 cm
304 stainless steel, 30 x 30 cm square showerhead

Cod.
G26S040C



G1/2"



7

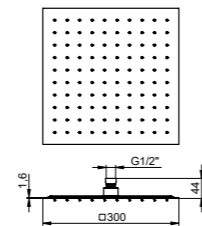

□ **AURORA**



Flessibile cm. 150 Acciaio 304 cromato a doppia
graffatura 1/2" - 1/2" conico
Double interlock chromed Aisi 304 stainless steel 150
cm. flexible hose 1/2" f - 1/2" conic

Cod.
G50S006C



G1/2"



50



Flessibile PVC cono 1/2" F - dado 1/2" F 150 cm
PVC flexible hose 150 cm. flexible hose 1/2" f - 1/2"
conic

Cod.
G50S002C



G1/2"



50



Doccetta quadra monogetto anticalcare in ABS
ABS square single jet anti lime handshower

Cod.
G26S013C



G1/2"



20

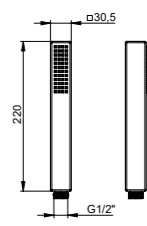

Piletta click-clack ABS
ABS click-clack waste

Cod.
P11S03



10

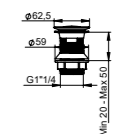

☐ **AURORA**



Miscelatore monocomando per cucina
Kitchen mixer

Cod.
■ **45S950C**

↑ G3/8" A76010N

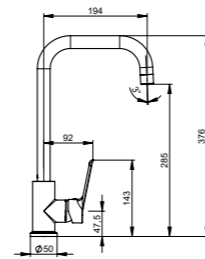

Miscelatore monocomando per cucina
Kitchen mixer

Cod.
■ **45S700C**

↑ G3/8" VG21048N A76010N

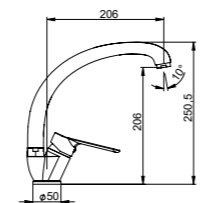

Miscelatore lavello a parete
Wall mount kitchen mixer

Cod.
■ **45S850C**

↑ G1/2" VG21048N A76010N

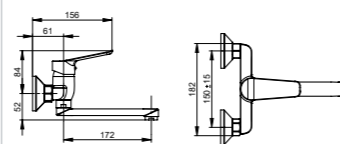



RICAMBI

SPARES

□ RICAMBI

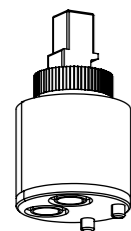

Cartuccia miscelatrice
Mixing cartridge

Cod.
VG21054N
VG21051N
VG21052N
VG20042N
VG21048N

□ RICAMBI



Aeratore
Aerator

Cod.
A76026N-1.5GPM
A76010N
A76039N-1.5GPM
A76053N-1.5GPM
A76030N-1.5GPM

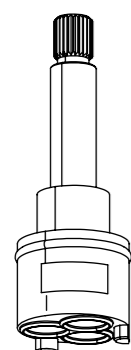

Cartuccia deviatore
Diverter cartridge

Cod.
VG20145N
VG20146N
VG20101C
VG20144N



Chiavetta aeratore. Non inclusa, ordinabile a parte.
Aerator key. Not included, to be ordered separately.

Cod.
A72005N
A72007N
A72006N



AVVERTENZE

Le superfici in qualsiasi finitura sono facilmente attaccabili da detergenti acidi e granulosi, da spugne ruvide o pagliette in metallo o comunque abrasive.

Le parti in materiali organici quali o-ring, guarnizioni, componenti plastici etc. sono facilmente deteriorabili tramite detersivi a base di alcool, disinfettanti o altri solventi, o per esposizione diretta a luce solare e aria.

IMPORTANTE: Per togliere sporcizia e calcare è sufficiente pulire i prodotti frequentemente con acqua e sapone neutro, non lasciare agire a lungo il prodotto, risciacquare abbondantemente e asciugare con un panno pulito. Una cattiva manutenzione, cura o pulizia possono causare il decadimento anticipato della garanzia.

WARNINGS

Surfaces in any finish are easily damaged by acidic and granular detergents, rough sponges or metal or abrasive scouring pads.

Parts made of organic materials such as O-rings, gaskets, plastic components, etc. are easily damaged by alcohol-based detergents, disinfectants or other solvents, or by direct exposure to sunlight and air.

IMPORTANT: Just clean the products frequently with water and neutral soap, do not leave any chemical for long time on the surface, rinse thoroughly and dry with a clean cloth. Poor maintenance, care or cleaning may result in premature termination of the warranty.

SOL è un marchio di Artis rubinetterie Srl
SOL is a registered trademark of Artis rubinetterie Srl

Via Mattei, 14
25060 Collebeato (BS) – Italy
Phone: +39 030 26 80 854
info@solrubinetterie.com

Per altre informazioni e le condizioni di vendita consulta il nostro sito
For any additional info and sales conditions please visit our website

www.solrubinetterie.com

Le Informazioni, immagini, schede tecniche, prezzi etc. inserite in questo listino sono da considerare puramente indicative. L'azienda si riserva il diritto di apportare modifiche, migliorie e variazioni necessarie, senza alcun obbligo di preavviso.
Tutti i diritti riservati: sono vietati la riproduzione e l'adattamento, parziali o totali, con qualsiasi mezzo, senza preventiva autorizzazione scritta del detentore del copyright.

All information, images, technical specifications, and prices included in this price list are for illustrative purposes only. The Company reserves the right to make any necessary modifications, improvements, or variations at any time, without prior notice.

All Rights Reserved: Total or partial reproduction or adaptation by any means is strictly prohibited without the prior written authorization of the copyright holder.

PREMESSA E AMBITO DI APPLICAZIONE

Le presenti Condizioni Generali di Vendita (di seguito "CGV") disciplinano i contratti di compravendita dei prodotti a marchio Artis o SOL tra Artis S.r.l. (di seguito "Azienda") e l'Acquirente (di seguito "Cliente"). L'effettuazione di un ordine implica l'accettazione integrale delle presenti CGV.

I. ORDINI, PERFEZIONAMENTO DEL CONTRATTO E FORO COMPETENTE

Art. 1 - Proposta d'Acquisto e Accettazione dell'Ordine

- L'ordine inoltrato dal Cliente (sia esso Professionista/Azienda o Consumatore) costituisce una mera proposta contrattuale irrevocabile per un periodo di 30 giorni.
- Il contratto di vendita si intenderà perfezionato e valido solo ed esclusivamente al momento dell'accettazione espressa e scritta dell'ordine da parte di Artis S.r.l. (mediante invio di Conferma d'Ordine). Fino a tale accettazione, l'Azienda è libera di non dare corso all'ordine senza che ciò comporti alcun onere o responsabilità a suo carico.
- Qualsiasi deroga o modifica alle presenti CGV dovrà essere espressamente accettata per iscritto dall'Azienda.

Art. 2 - Foro Competente

- Fatto salvo quanto inderogabilmente previsto dalla legge in caso di Cliente Consumatore (D.Lgs. 206/2005 - Codice del Consumo), per qualsiasi controversia derivante o comunque connessa ai contratti disciplinati dalle presenti CGV, sarà regolata secondo la legge italiana e sarà competente in via esclusiva il Foro di Brescia.

II. GARANZIA CONVENZIONALE E LEGALE

Art. 3 - Durata e Oggetto della Garanzia Convenzionale

- L'Azienda garantisce i propri prodotti contro i difetti di conformità e i vizi occulti per il periodo e alle condizioni specificate di seguito. La garanzia si limita alla riparazione o sostituzione del prodotto riconosciuto come difettoso.
- Garanzia Estesa (5 Anni):** Prodotti con finitura Cromo e prodotti in materiale Acciaio senza alcuna finitura superficiale.
- Garanzia Standard (2 Anni):** Tutti gli altri prodotti non rientranti nel punto precedente.
- Nel caso in cui il Cliente rivesta la qualifica di Consumatore, si applica la garanzia legale di conformità di due (2) anni dalla consegna, impregiudicata l'applicazione della garanzia convenzionale se più favorevole.

Art. 4 - Decadenza della Garanzia

La garanzia, sia essa legale o convenzionale, decade immediatamente nei seguenti casi:

- Uso Improprio e Non Conforme.**
- Mancata o Non Conforme Manutenzione.**
- Utilizzo di Prodotti Aggressivi** (detergenti acidi, basici, solventi, cloruri).
- Abrasione Chimica o Meccanica** (spugne ruvide, pagliette).
- Danni da Acqua** (eccessiva durezza o calcare non rimosso).
- Alterazioni e Riparazioni non Autorizzate.**
- Danneggiamento Esterno** (trasporto non imputabile all'Azienda, cadute).
- Mancato Rispetto delle Istruzioni di Montaggio.**
- Installazione del prodotto con Vizi Palesi:** La garanzia per difetti estetici visibili o vizi palesi (quali graffi, ammaccature o imperfezioni della finitura) decade tassativamente nel momento in cui il prodotto viene installato. **L'installazione e la posa in opera implicano l'accettazione incondizionata del prodotto da parte del Cliente e sanano ogni eventuale difetto estetico rilevabile al momento della ricezione.** Qualsiasi contestazione estetica deve pertanto essere sollevata prima di procedere al montaggio.

III. POLITICA SUI RESI PER NON CONFORMITÀ O VIZI

Art. 5 - Procedura di Richiesta di Reso e Valutazione

- Richiesta di Reso (Denuncia del Difetto):** Il Cliente deve inoltrare la richiesta entro i termini di legge. In caso di **vizi estetici palesi**, la denuncia deve avvenire prima dell'installazione del prodotto (rif. Art. 4.9). La comunicazione deve avvenire via e-mail o PEC.
- Documentazione Obbligatoria:** La richiesta deve includere Numero Fattura/DDT, descrizione dettagliata del difetto e documentazione fotografica/video chiara.
- Autorizzazione al Rinvio (Ritiro):** Il Cliente può restituire il prodotto SOLO PRE-VIA ACCETTAZIONE SCRITTA di Artis S.r.l.
- Valutazione Tecnica:** L'Azienda verificherà la fondatezza del difetto e la sua imputabilità produttiva.

Art. 6 - Addebiti in Caso di Non Imputabilità Qualora il difetto non sia imputabile ad Artis S.r.l. (es. per cause di decadenza ex Art. 4), l'Azienda si riserva il diritto di:

- Addebitare i costi di gestione e analisi tecnica.
- Addebitare il costo di eventuali prodotti sostitutivi già inviati in via provvisoria.
- Restituire il prodotto originale al Cliente previo pagamento dei costi sopra indicati.

PREAMBLE AND SCOPE OF APPLICATION

These General Terms and Conditions of Sale (hereinafter "GTC") govern the sales contracts for SOL or Artis branded products between Artis S.r.l. (hereinafter the "Company") and the Purchaser (hereinafter the "Customer"). The placement of an order implies the full and unreserved acceptance of these GTC.

I. ORDERS, FORMATION OF CONTRACT, AND JURISDICTION

Art. 1 - Purchase Proposal and Order Acceptance

- Any order submitted by the Customer (whether a Business Entity or a Consumer) constitutes an irrevocable contractual proposal for a period of 30 days.
- The sales contract shall be deemed executed and binding only upon express written acceptance of the order by Artis S.r.l. (via an Order Confirmation). Until such acceptance, the Company remains free to decline the order without any liability or obligation.
- Any derogation or amendment to these GTC must be expressly accepted in writing by the Company.

Art. 2 - Exclusive Jurisdiction

- Without prejudice to mandatory provisions of law regarding Consumer Customers (EU Directive 2011/83), any dispute arising out of or in connection with the contracts governed by these GTC shall be subject to the Italian Law, and **exclusive jurisdiction of the Court of Brescia, Italy.**

II. COMMERCIAL AND STATUTORY WARRANTY

Art. 3 - Duration and Scope of the Commercial Warranty

- The Company warrants its products against manufacturing defects and latent defects for the periods specified below. The warranty is strictly limited to the repair or replacement of the product recognized as defective.
- Extended Warranty (5 Years):** Products in Chrome finish and Brushed Stainless Steel products without surface coating.
- Standard Warranty (2 Years):** All other products not specified above.
- For Customers qualifying as "Consumers," the statutory 2-year legal warranty of conformity applies, without prejudice to the commercial warranty if more favorable.

Art. 4 - Forfeiture and Voiding of Warranty

The warranty (both statutory and commercial) shall be immediately voided in the following cases (including but not limited to):

- Improper or Non-Compliant Use.**
- Failure to Perform Maintenance** or maintenance not compliant with Company instructions.
- Use of Aggressive Chemicals** (acidic or basic detergents, solvents, chlorides).
- Chemical or Mechanical Abrasion** (scouring pads, abrasive sponges).
- Water-Related Damage** (excessive water hardness or failure to remove limescale deposits).
- Unauthorized Alterations or Repairs.**
- External Damage** (scratches or dents caused by transport not attributable to the Company, or accidental drops).
- Failure to Follow Installation Instructions.**
- Installation of Products with Patent Defects:** The warranty for visible aesthetic defects or patent defects (such as scratches, dents, or finish imperfections) is strictly **voided upon installation.** The installation and commissioning of the product constitute **unconditional acceptance** by the Customer and "cure" any aesthetic defect detectable at the time of delivery. Any aesthetic claim must therefore be submitted **prior to installation.**

III. RETURN POLICY FOR NON-CONFORMITY OR DEFECTS

Art. 5 - Return Request Procedure and Evaluation

- Claim Submission:** The Customer must report any defect within the statutory/contractual time limits. In the case of **patent aesthetic defects**, the claim must be submitted before the product is installed (ref. Art. 4.9). Claims must be sent via e-mail or Registered Mail (PEC).
- Mandatory Documentation:** The request must include: Invoice/Delivery Note (DDT) references, a detailed description of the defect, and clear photographic or video evidence.
- Return Authorization (RMA):** The Customer may return the product ONLY AFTER RECEIVING WRITTEN AUTHORIZATION from Artis S.r.l.
- Technical Evaluation:** Upon receipt, the Company will perform a technical analysis to verify the nature of the defect and its attributability to the manufacturing process.

Art. 6 - Charges for Non-Attributable Defects If the technical evaluation (as per Art. 5) determines that the defect is not attributable to Artis S.r.l. (e.g., due to any forfeiture clause in Art. 4), the Company reserves the right to:

- Charge the Customer for return handling costs, including shipping and technical analysis fees.
- Invoice the cost of any replacement products already provided to the Customer on a provisional basis.
- Return the original product to the Customer at their expense, subject to payment of the aforementioned handling fees.



A. CHI È IL GARANTE DA CONTATTARE?

SOL se hai acquistato direttamente, oppure contatta il rivenditore presso il quale hai acquistato il prodotto SOL.

B. COSA È COPERTO DALLA GARANZIA SOL?

La garanzia SOL copre la riparazione o la sostituzione del prodotto SOL, che presenti difetti di fabbricazione o di materiali, entro il periodo di garanzia e nei limiti di seguito descritti. Se una parte non dovesse essere disponibile (ad esempio, particolare variazione di colore) SOL la sostituirà con una parte di ricambio funzionale che sia idonea a ripristinare la conformità del bene.

C. COSA NON È COPERTO DALLA GARANZIA SOL?

I prodotti SOL sono progettati e costruiti per fornire prestazioni elevate e costanti in ambienti domestici normali. Se un prodotto SOL viene utilizzato nel modo previsto e si guasta entro il periodo di garanzia, è nostra responsabilità fornirne uno in sostituzione o fornire i componenti necessari per la riparazione.

Ci sono, tuttavia, alcune circostanze in cui la garanzia SOL non copre la riparazione o la sostituzione di un prodotto. Non sono coperti da garanzia:

- Normale usura, compresa quella delle parti che si usurano col tempo (ad esempio, lista non esaustiva, o-ring, guarnizioni, flessibili, tette, e in generale tutte le parti e i componenti realizzati in materiali diversi dall'ottone o l'acciaio, come ad esempio, ceramica, ABS, gomma, nylon, materiali plastici, metalli diversi da ottone e acciaio, ecc.)
- Danno accidentale, Danno derivante da un uso non conforme, Danni causati dalla mancata corretta manutenzione del prodotto
- Danni causati dall'uso di prodotti impropri per la pulizia quali, a titolo esemplificativo e non esaustivo:
- Spugne o pagliette abrasive. Prodotti di pulizia aggressivi e comunque non adatti alla corretta pulizia del prodotto (per maggiori informazioni sulla pulizia vedi: AVVERTENZE su cura e manutenzione del prodotto)
- Rimozione o modifica di componenti.
- Danni da fonti esterne, quali trasporto, condizioni atmosferiche, qualità dell'acqua degli impianti o sbalzi di pressione negli impianti.
- Guasti causati da circostanze al di fuori del controllo di SOL; Guasti causati da: Uso negligente, uso improprio o incuria nell'uso del prodotto; Utilizzo di un prodotto SOL per scopi diversi dal normale uso portato a conoscenza del consumatore; Utilizzo di parti non montate o non installate secondo le istruzioni di SOL; Uso di parti e accessori che non sono componenti originali SOL. La gamma completa di ricambi e accessori originali SOL per tutti i prodotti SOL è disponibile sul sito. Guasti causati da montaggio o installazione difettosi per cause non imputabili a SOL; Riparazioni o modifiche effettuate senza previa autorizzazione da parte di SOL.

In caso di dubbi, il nostro servizio di assistenza clienti è disponibile gratuitamente al numero +39 030 26 80 854 oppure via email a: info@solrubinetterie.com. Un esperto SOL ti spiegherà cosa fare.

D. QUALI SONO I TERMINI E LE CONDIZIONI DELLA GARANZIA?

La garanzia SOL è soggetta ai seguenti termini e condizioni:

- La garanzia entra in vigore alla data di acquisto. È necessario fornire la prova di acquisto prima che si possa eseguire qualsiasi intervento sul prodotto in garanzia. Senza la prova di acquisto tutti gli interventi effettuati saranno a pagamento. Si prega di conservare la ricevuta d'acquisto o la bolla di consegna.
- La riparazione o la sostituzione del prodotto in garanzia non prolunga il periodo di garanzia.

E. COME RICHIEDERE L'APPLICAZIONE DELLA TUA GARANZIA?

Per richiedere l'applicazione della garanzia SOL al tuo prodotto, contatta il nostro Servizio Clienti attraverso uno qualsiasi dei canali indicati nella sezione "Contattaci".

Per effettuare una riparazione o una sostituzione in garanzia SOL, è necessario fornire la prova di acquisto e una descrizione dettagliata possibilmente anche fotografica del malfunzionamento, prima che si possa dare seguito a qualsiasi richiesta relativa al prodotto in garanzia (scontrino di acquisto, fattura, conferma dell'ordine e/o della consegna, ecc.).

F. QUANDO ENTRA IN VIGORE E QUANTO DURA LA GARANZIA?

La garanzia SOL entra in vigore alla data di acquisto del prodotto ed avrà la validità di seguito indicata da quel momento. Tale periodo si applica a tutti i prodotti nuovi. Si precisa che l'usura normale e il deterioramento prevedibile nel tempo non rientrano nella copertura della garanzia legale di conformità:

- 5 anni di garanzia: Prodotti cromati e prodotti in acciaio spazzolato privi di finitura
- 2 anni di garanzia: Prodotti in qualsiasi finitura escluso il cromo.

A. WHO IS THE GUARANTOR TO CONTACT?

SOL if you purchased directly, or contact the retailer from whom you purchased the SOL product.

B. WHAT DOES THE SOL WARRANTY COVER?

The SOL warranty covers the repair or replacement of the SOL product that has manufacturing or material defects within the warranty period and within the limits described below. If a part is not available (for example, a particular color variation) SOL will replace it with a functional spare part that is suitable for restoring the conformity of the product.

C. WHAT IS NOT COVERED BY THE SOL WARRANTY?

SOL products are designed and built to provide consistent high performance in normal household environments. If a SOL product is used as intended and fails within the warranty period, it is our responsibility to provide a replacement or to supply the necessary parts for repair.

There are, however, some circumstances where the SOL warranty does not cover the repair or replacement of a product. The following are not covered by the warranty:

- Normal wear and tear, including that of parts that wear out over time (for example, non-exhaustive list, O-rings, gaskets, hoses, teats, and in general all parts and components made of materials other than brass or steel, such as ceramic, ABS, rubber, nylon, plastic materials, metals other than brass and steel, etc.)
- Accidental damage, Damage resulting from improper use, Damage caused by failure to properly maintain the product
- Damage caused by the use of inappropriate cleaning products such as, by way of example and not limited to:
- Abrasive sponges; Aggressive chemical products and in any case not suitable for the correct cleaning of the item (for more information on cleaning see: WARNINGS on product use and care)
- Removal or modification of components.
- Damage from external sources, such as transport, atmospheric conditions, quality of the water in the systems or pressure changes in the systems.
- Failures caused by circumstances beyond the control of SOL.
- Failures caused by: Negligent use, improper use or carelessness in the use of the product; Use of a SOL product for purposes other than normal use made known to the consumer; Use of parts not assembled or installed according to the instructions of SOL; Use of parts and accessories that are not original SOL components. The full range of original SOL spare parts and accessories for all SOL products is available on the site.
- Faulty assembly or installation for reasons not attributable to SOL; Repairs or modifications carried out without prior authorization from SOL.

If you have any doubts, our customer service is available free of charge on +39 030 26 80 854 or by email at: info@solrubinetterie.com. A SOL expert will explain what to do.

D. WHAT ARE THE TERMS AND CONDITIONS OF THE WARRANTY?

The SOL warranty is subject to the following terms and conditions:

- The warranty is effective from the date of purchase. Proof of purchase must be provided before any work can be carried out on the product under warranty. Without proof of purchase all work carried out will be chargeable. Please retain your receipt or delivery note.
- Repair or replacement of the product under warranty will not extend the warranty period.

E. HOW TO APPLY YOUR WARRANTY?

To apply the SOL warranty to your product, contact our Customer Service through any of the channels indicated in the "Contact Us" section.

To carry out a repair or replacement under the SOL warranty, it is necessary to provide proof of purchase and a detailed description, possibly also photographic, of the malfunction, before any request relating to the product under warranty can be followed up (purchase receipt, invoice, order and/or delivery confirmation, etc.).

F. WHEN DOES THE WARRANTY COME INTO FORCE?

The warranty comes into force on the date of purchase of the product, and will be valid as indicated below from that moment. This period applies to all new products. It should be noted that normal wear and tear and foreseeable deterioration over time are not covered by the legal guarantee of conformity.

- 5 years warranty: Chromed products and steel products
- 2 years warranty: Products in any finish except chrome

SOL
RUBINETTERIE

SOL è un marchio di Artis rubinetterie Srl
SOL is a registered trademark of Artis rubinetterie Srl

Via Mattei, 14
25060 Collebeato (BS) – Italy
Phone: +39 030 26 80 854
info@solrubinetterie.com

